

! INFO !

- (DE) Die Batterie des Zugfahrzeugs bzw. gezogenen Fahrzeugs nicht direkt über die Steckdose aufladen.
- (FR) Ne pas charger les batteries du véhicule tracteur et/ou tracté directement sur la prise de courant.
- (NL) De accu van het trekkend voertuig c.q. getrokken voertuig niet rechtstreeks via de contactdoos opladen.
- (GB) Do not charge the battery of the towing vehicle and/or towed vehicle directly via the socket.
- (ES) No recargue la batería del vehículo remolque y/o del remolcado directamente mediante el enchufe.
- (IT) Non caricare la batteria del veicolo trainante o di quello trainato direttamente dalla presa.
- (SE) Ladda inte batteriet i det bogserande fordonet och/eller det bogserade fordonet direkt via kontakten.
- (CZ) Nenabíjete baterii tažného ani taženého vozidla přes zásuvku.
- (DK) Oplad ikke bugseringskøretøjet og/eller det bugserede køretøjs batteri direkte v.h.a. stikdåsen.
- (FI) Älä lataa hinaavan ajoneuvon ja/tai hinattavan ajoneuvon akkuja suoraan pistorasian kautta.
- (GR) Μη φορτίζετε την μπαταρία του ρυμουλκούμενου οχήματος και/ή ρυμουλκημένου οχήματος απευθείας μέσω του ρευματοδότη.
- (NO) Batteriet til kjøretøyet som trekker eller blir trukket skal ikke lades direkte via koblingsboksen.
- (PL) Nie ładować akumulatora pojazdu holującego/holowanego bezpośrednio przez gniazdo.

- (DE) Gebrauchsanleitung
(FR) Mode d'emploi
(NL) Gebruikershandleiding
(GB) User guide
(ES) Guía del usuario
(IT) Manuale di istruzioni
(SE) Bruksanvisning
(CZ) Uživatelská příručka
(DK) Brugervejledning
(FI) Käyttöohjeet
(GR) Οδηγός χρήστη
(NO) Brukerveiledning
(PL) Instrukcja obsługi

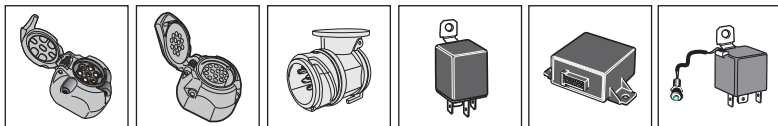
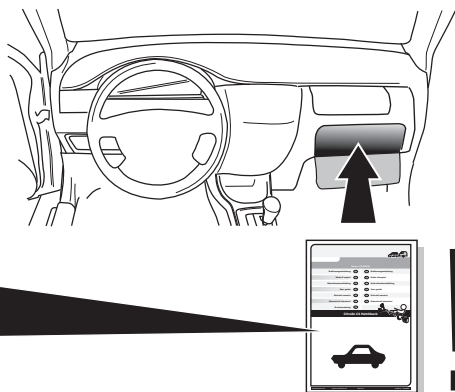

SPARE PARTS

www.ecs-electronics.com

ECS

ELECTRONICS



Partnr.: CT-003-DB

Gebrauchsanleitung (DE)

(CZ) Uživatelská příručka

Mode d'emploi (FR)

(DK) Brugervejledning

Gebruikershandleiding (NL)

(FI) Käyttöohjeet

User guide (GB)

(GR) Οδηγός χρήστη

Guía del usuario (ES)

(NO) Brukerveiledning

Manuale di istruzioni (IT)

(PL) Instrukcja obsługi

Bruksanvisning (SE)

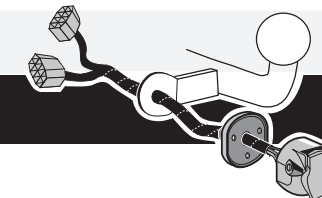

Citroën Xsara Picasso 1999-

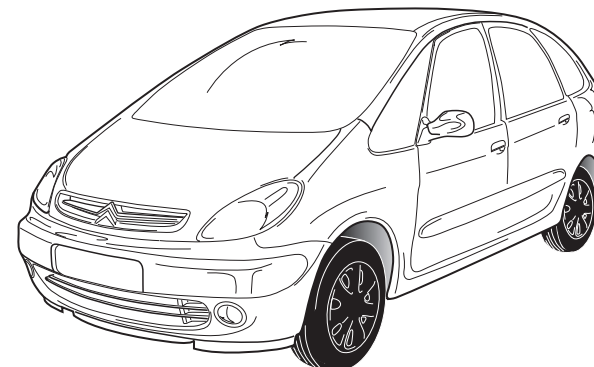

INFO

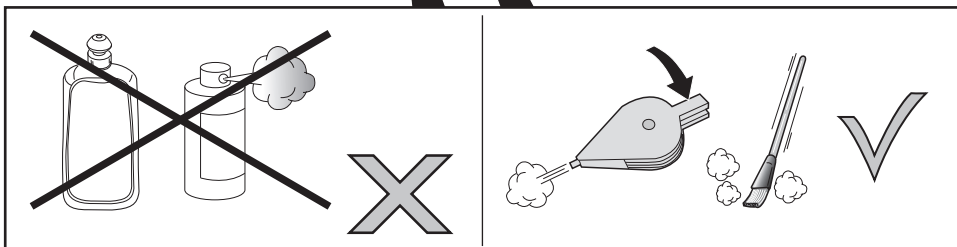
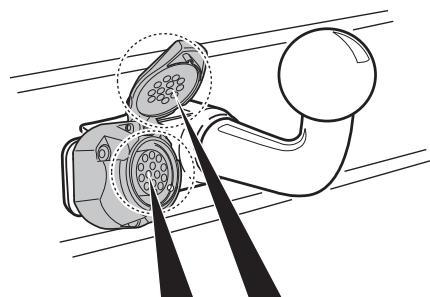
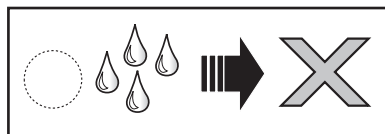
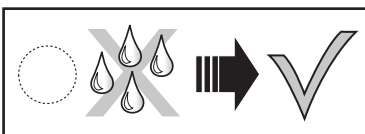
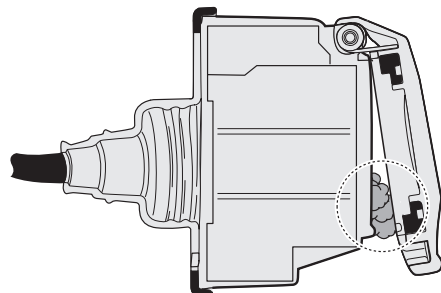
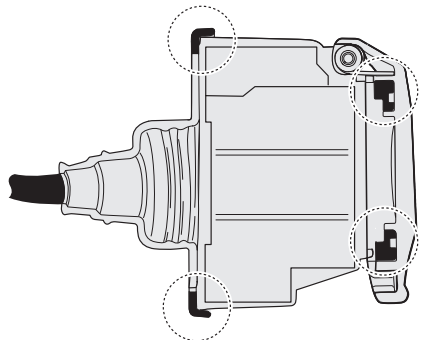
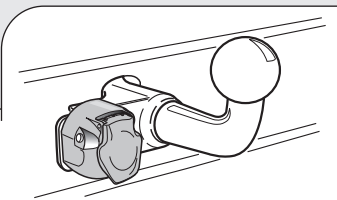
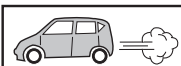

- (DE)** Falls zutreffend soll bei einem angekoppelten Anhänger mit einer Nebelleuchte in Betrieb die Nebelleuchte des Fahrzeugs ausgeschaltet werden.
- (FR)** Le cas échéant, lorsqu'une remorque, avec des anti-brouillard actifs, est branchée, les anti-brouillards du véhicule seront déconnectés.
- (NL)** Indien van toepassing zal bij een gekoppelde aanhanger met een werkende mistlamp de mistlamp van het voertuig worden uitgeschakeld.
- (GB)** In a coupled trailer with working fog lamp, the fog lamp of the vehicle will be switched off, if applicable.
- (ES)** En un remolque acoplado con faros antiniebla en funcionamiento, se apagarán, si es aplicable, los faros antiniebla del vehículo.
- (IT)** Se applicabile, in presenza di un rimorchio agganciato con una luce antinebbia in funzione, l'antinebbia del veicolo viene disinserito.
- (SE)** Om tillämpligt kopplas ett fungerande dimljus bort från det anslutna släpet.
- (CZ)** Pokud je na připojeném přívěsu zapnuta mlhovka, bude tato mlhovka na přívěsu vypnuta.
- (DK)** Hvis det er relevant, vil på en tilkoblet anhænger med en fungerende tågelygte vognens tågelygte frakobles.
- (FI)** Jos liitetyssä perävaunussa on toimiva sumuvalo, ajoneuvon sumuvalo kytketään pois päältä.
- (GR)** Σε συζευγμένο ρυμουλκό στο οποίο λειτουργεί φανός ομίχλης, ο φανός ομίχλης του οχήματος θα απενεργοποιηθεί, εφόσον ενδείκνυται.
- (NO)** Om nødvendig skal kjøretøyes tåkelys slås av, dersom tilhengeren som kobles til selv har et fungerende tåkelys.
- (PL)** W stosownych przypadkach, przy przyłączonej przyczepie z działającymi światłami przeciwmgielnymi, zostaną wyłączone światła przeciwmgielne pojazdu.

(DE) Anschluss Steckdose
 (FR) Connection de la prise
 (NL) Contactdoos aansluiting
 (GB) Socket connection

(ES) Conexión de la caja de enchufe
 (IT) Allaccio zoccolo
 (SE) Anslutning kontaktdosa

(CZ) Objímkový konektor
 (DK) Stikkdåse forbindeelse
 (FI) Pistorasia liitäntä

(GR) Υποδοχή σύνδεσης
 (NO) Tilkobling koblingsboks
 (PL) Połączenie przez gniazdo

DIN/ISO 11446	↔	⚡	⚡	⚡	⚡	⚡	⚡	⚡	⚡	⚡	⚡	⚡	⚡	⚡	⚡	⚡	⚡	⚡
P max	1/L	2	2x21W	2a	1-8	4/R	5/58-R	6/54	7/58-L	8	9	10	11	12	13	9		
(DE)	Gelb	Blau	Blau	Grau	Weiß	Grün	Braun	Rot (1,00mm ²)	Schwarz	Schwarz/ Rot	Braun/ Weiß	Rot (2,50mm ²)	Weiß	Rot/ Blau	Weiß	Rot (2,50mm ²)		
(FR)	Jaune	Bleu	Bleu	Gris	Blanc	Vert	Marron	Rouge (1,00mm ²)	Noir	Noir/ Rouge	Marron/ Blanc	Rouge (2,50mm ²)	Blanc	Rouge/ Bleu	Blanc	Rouge/ Bleu (2,50mm ²)		
(NL)	Geel	Blauw	Blauw	Grijs	Wit	Groen	Bruin	Rood (1,00mm ²)	Zwart	Zwart/ Rood	Bruin/ Wit	Rood (2,50mm ²)	Wit	Rood/ Blauw	Wit	Rood/ Blauw (2,50mm ²)		
(GB)	Yellow	Blue	Blue	Grey	White	Green	Brown	Red (1,00mm ²)	Black	Black/ Red	Brown/ White	Red (2,50mm ²)	White	Red/ Blue	White	Red/ Blue (2,50mm ²)		
(ES)	Amarillo	Azul	Azul	Gris	Blanco	Verde	Marrón	Rojo (1,00mm ²)	Negro	Negro/ Rojo	Marrón/ Blanco	Rojo (2,50mm ²)	Blanco	Rojo/ Azul	Blanco	Rojo/ Azul (2,50mm ²)		
(IT)	Giallo	Blu	Blu	Grigio	Bianco	Verde	Marrone	Rosso (1,00mm ²)	Nero	Nero/ Rosso	Marrone/ Bianco	Rosso (2,50mm ²)	Bianco	Rosso/ Blu	Bianco	Rosso/ Blu (2,50mm ²)		
(SE)	Gul	Blå	Blå	Grå	Vit	Grön	Brun	Röd (1,00mm ²)	Svart	Svart/ Röd	Brun/ Vit	Röd (2,50mm ²)	Vit	Röd/ Blå	Vit	Röd/ Blå (2,50mm ²)		
(CZ)	Žlutá	Modrá	Modrá	Šedá	Bílá	Zelená	Hnědá	Červená (1,00mm ²)	Černá	Černo/ Červená	Hnědo/ Bílá	Červená (2,50mm ²)	Bílá	Červená/ Modrá	Bílá	Červená/ Modrá (2,50mm ²)		
(DK)	Gul	Blå	Blå	Grå	Hvid	Grøn	Brun	Rød (1,00mm ²)	Sort	Sort/ Rød	Brun/ Hvid	Rød (2,50mm ²)	Hvid	Rød/ Blå	Hvid	Rød/ Blå (2,50mm ²)		
(FI)	Keltainen	Sininen	Sininen	Harmaa	Valkoinen	Vihreä	Ruskea	Punainen (1,00mm ²)	Musta	Musta/ Punainen	Ruskea/ Valkoinen	Punainen (2,50mm ²)	Valkoinen	Punainen/ Sininen	Valkoinen	Punainen/ Sininen (2,50mm ²)		
(GR)	Κίτρινο	Μπλε	Μπλε	Γκρι	Λευκό	Πράσινο	Καφέ	Κόκκινο (1,00mm ²)	Μαύο	Μαύο/ Κόκκινο	Καφέ/ Λευκό	Κόκκινο (2,50mm ²)	Λευκό	Κόκκινο/ Μπλε	Λευκό	Κόκκινο/ Μπλε (2,50mm ²)		
(NO)	Gul	Blå	Blå	Grå	Hvit	Grønn	Brun	Rød (1,00mm ²)	Svart	Svart/ Rød	Brun/ Hvit	Rød (2,50mm ²)	Hvit	Rød/ Blå	Hvit	Rød/ Blå (2,50mm ²)		
(PL)	Żółty	Niebieski	Niebieski	Szary	Biały	Zielony	Brązowy	Czerwony (1,00mm ²)	Czarny	Czarny/ Czerwony	Brązowy/ Biały	Czerwony (2,50mm ²)	Biały	Czerwony/ Niebieski	Biały	Czerwony/ Niebieski (2,50mm ²)		

INFO : Storage

INFO : Ring.

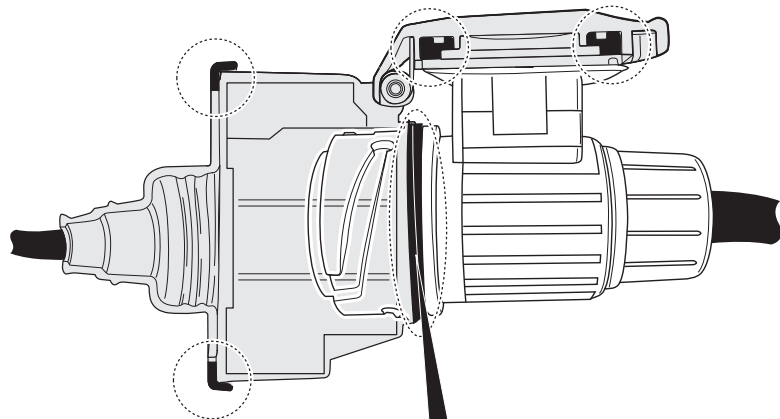
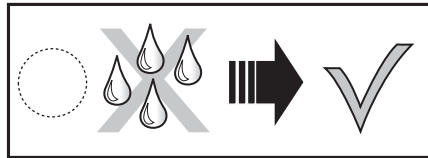
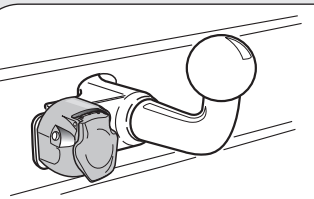
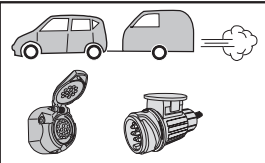

INFO

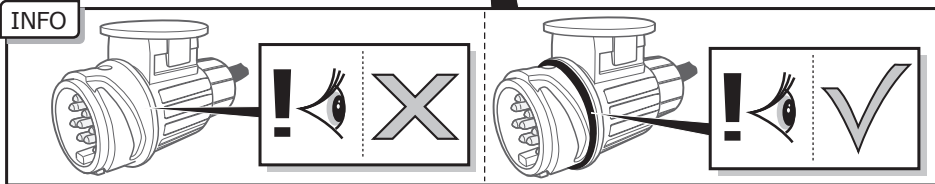

INFO : Adapt.

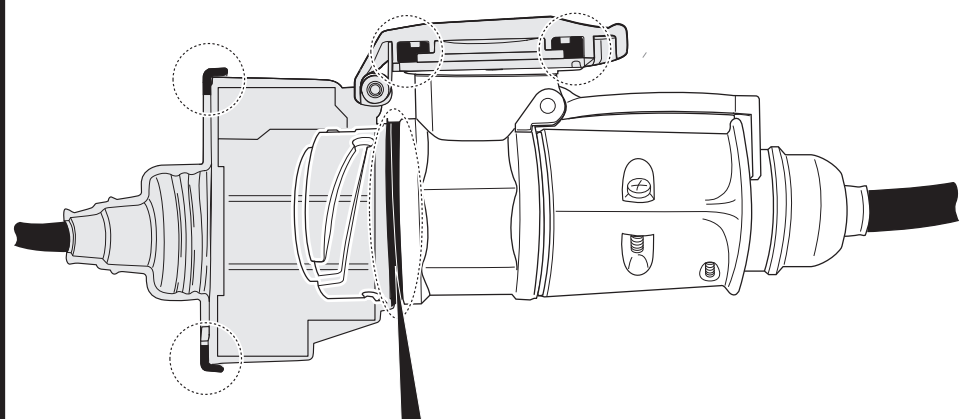
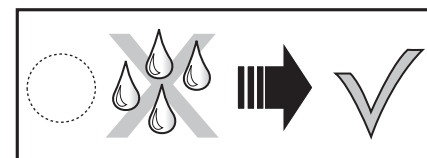
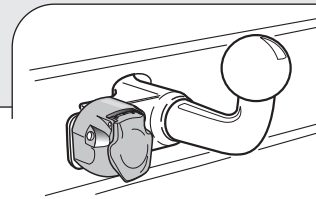
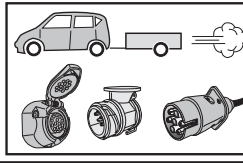

INFO

